

## Tools You Will Need

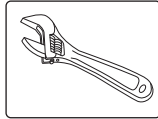

Plumber's putty



Adjustable Wrench

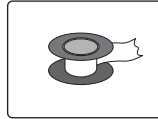

Pipe Tape

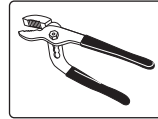

Groove joint plier

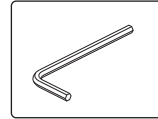

Allen Wrench

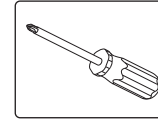

Phillips Screwdriver

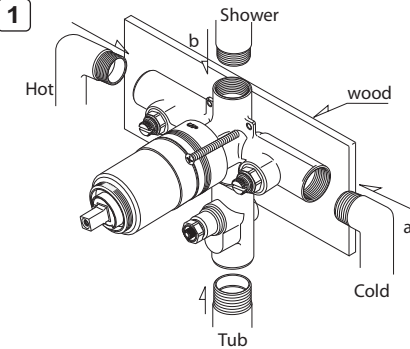

1  
Once the location has been determined, install a crossbeam. Level the valve and secure to the crossbeam. Connect valve to the hot and cold supplies using copper supply lines. (Note: Do not apply heat directly to the valves as this may damage rubber and plastic seals and will void the warranty) Connect the outlet port to the spout & to the shower head.

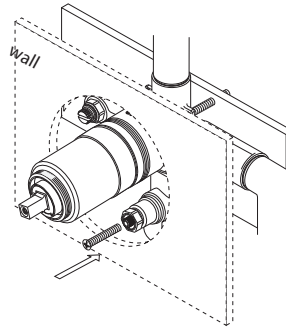

Before the finished wall is complete and the valve is fully installed make sure to test the valve function. The cartridge function, anti-scald function and the diverter function should all be checked to make sure that valve is working properly. (NOTE: The diverter needs to be flush with the finish wall)  
Hint: use a screw to test the diverter function.

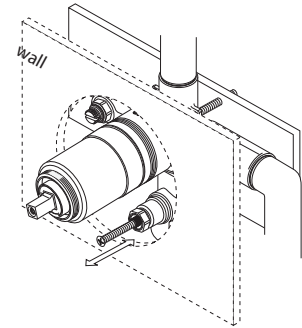

To test the valve function turn on the water check to make sure both hot and cold supply is working. If not enough hot water is supplied check the temperature limit stop. To check the anti scald turn off one side of the valve from the service stop, all water (hot & cold) should stop or come to a trickle. Next test the diverter function while water is on.

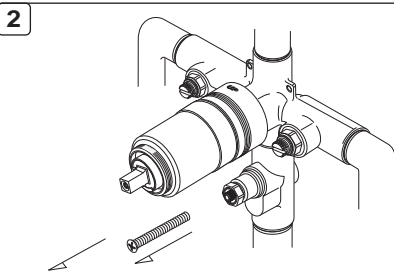

2  
Unscrew the screw from the push pull diverter. Make sure valve is straight and not installed at an angle. This is the last time to check and make sure valve body is installed properly before the trim is installed. (Hint: check main connection points and assure no leaks)

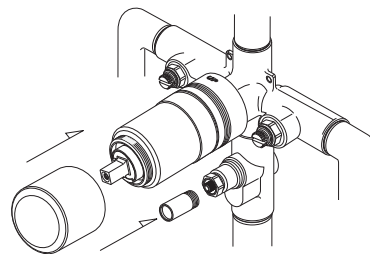

Install the sleeve to the raw sleeve on the valve body. From the outside slide the finished sleeve over the raw sleeve. It simply slips on to the valve.  
Install the push pull diverter sleeve. From the outside screw the diverter sleeve onto the outlet of the diverter mechanism. Simply screw the sleeve on by hand until it locks.

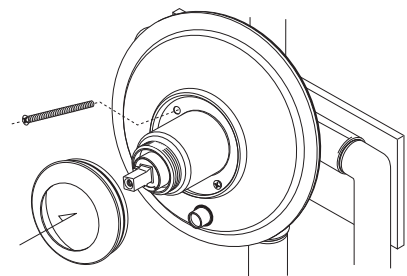

Slide the face plate over the valve. The face plate has a cap that needs to be taken off in order to screw on the screws to the valve. The cap can be removed by simply using your hands and twist it until it snaps off. Screw holes should be visible. Place face plate over the valve body and the diverter hole. Use screws supplied to screw it onto the valve. Place face plate cap over screw holes and push it into place so that screw holes are not visible

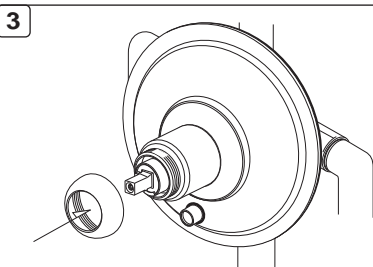

3  
Grab the sleeve cap, and place it over the cartridge portion of the valve. From the top screw the sleeve cap by simply twisting it to make sure it locks in place. Cap will hold the sleeve in place and prevent it from moving back and forth.

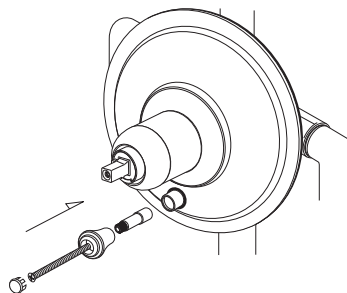

Install the push pull diverter trim. Place the diverter trim inside the diverter. From the outside slip the screw into the diverter trim. With a screwdriver, screw it onto the diverter, so that it locks the diverter trim to the diverter. Grab the diverter cap and snap it place, to cover the hole.

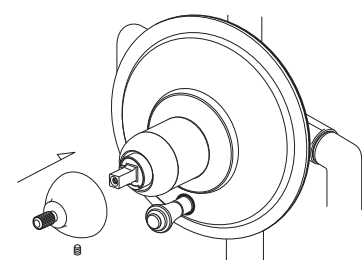

Install the adaptor. From the outside slip the adaptor onto the plastic square protruding from the cartridge. Make sure hole from the adaptor faces down. From below, grab an allen wrench and lock the allen screw, so that it locks the adaptor to the cartridge. (Note: Adaptor should not wiggle) NOTE: (The Atlantis does not require adaptor)

4

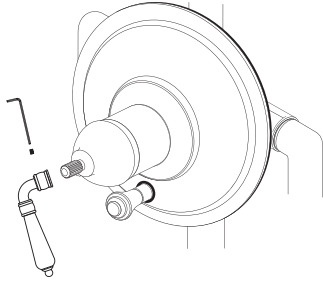

Install handle by placing it over and sliding it into the threaded portion of the adaptor. Next with an allen wrench tighten the lock nut on the handle so that it locks the handle to the adaptor. (Note: The handle should be tighten so that it does not wiggle)

