

MOBKxxNNL - Bridge Style Kitchen Faucet

Faucet installation

Tools You Will Need

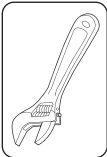

Adjustable Wrench

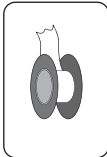

Pipe Tape



Silicone Caulking



Groove joint plier

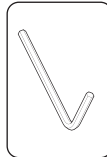

Allen Wrench

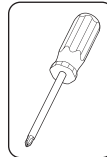

Phillips Screwdriver

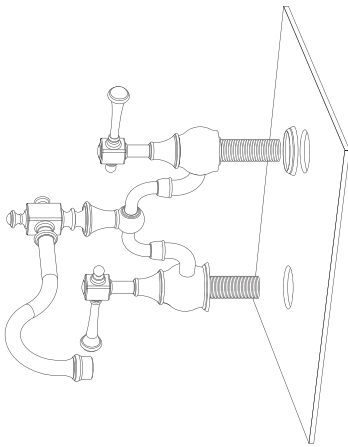

Install faucet:
Place the spout base rings on top of the counter top holes. Slide the threaded stem on the faucet down the counter top holes. Make sure the base rings sit between the faucet and the counter top.

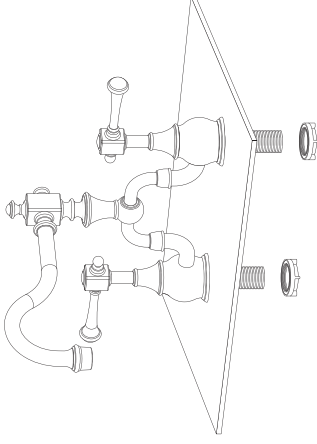

With the faucet now in place.
Hand tighten the wing nuts to the bottom of the threaded stems from the faucet.
Make sure that the wing nuts sit flush up against the countertop.
Make sure that the spout base rings sit firm down on the countertop. Adjust as needed.

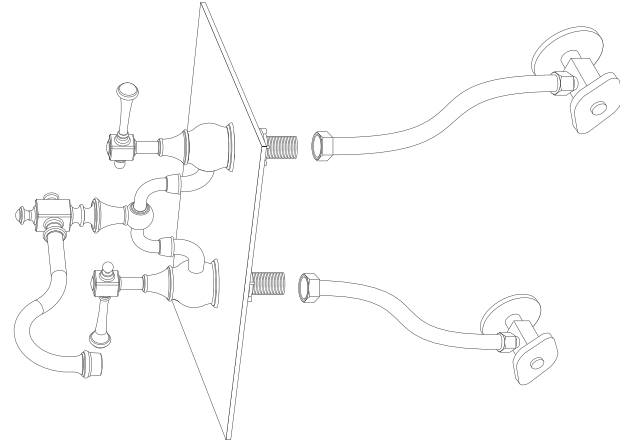

Connect the water supply lines:
Finally connect water supply lines from the house the spout body. Using the steel braided hoses not supplied, connect one end first to the bottom of the spout valve bodies. End hex nut on the hoses should be hand tightened plus an extra 1/2 turn with a wrench. Do not over tighten the hose connections.
Connect the water lines to appropriate hot and cold line from the house.

Flush the system:
You will need to flush and test the system. Unscrew the aerator from the spout. Turn the main water supply back on and turn on both the hot and cold valves. Let the water run for about 2-3 minutes. Check above and below the deck surface and at all major connection points for leakage.

Thank you for choosing Huntington Brass. Your new HB faucet is guaranteed to give you a life time of worry free, impeccable function.

