



EAGO

EAGO SANITARY WARE CO., LTD.

Add: Shiling Development Zone, Xiaotang Town, Nanhai District, Foshan City, GuangDong, China

Tel: 0757-86632966 86632235 86632866 Fax: 0757-86632609

EAGO

AM196JDTS-1Z Installation Instruction

Safety Information

- 1.Please read carefully and follow all instructions when operating.
- 2.Qualified earth leakage circuit-breaker must be installed and tested with trial jump to certify the device is qualified and safety before using the product.
- 3.To avoid electric shock, the replacing of the wire must be done by the electrical engineer or the retailer. Customer could not replace just by yourself. The wire for CT,TS series shall be:3*1.5 mm²; The wire for TS-1,CL,CW , CW1 and S series shall be 3*1.0 mm².
- 4.Ground wire of massage water pump and air pump must be connected to ground well, the minimum size copper wire of ground wire must not be less than 1.5mm².
- 5.It is forbid to remodel, add or take part products.
- 6.Please don't use this product after alcohol or drugs.
- 7.The children shall be closely supervised by parents to use product.
- 8.All the electrical spare parts except the remote control must be put suitable and stable to avoid slip into the tub.
- 9.Warning:the mixed water temperature shall never exceed 60 degree centigrade.
- 10.Don't use sulphuric acid, hydrochloric acid, lye and other mixed strong corrosive chemical liquid to clean product.
- 11.The water pump would be very hot when running.Please don't touch the surface of the machine to avoid scald.
- 12.The water level must be higher than the jet before turning on the product.
- 13.Please don't drop anything in or insert in water pump and the opening hole of machine.
- 14.Warning: Avoid electrical shock, the GFCI/RCD (Earth Leakage Circuit Breaker) must be installed to ground socket for protection.
- 15.Warning: Avoid electrical shock, not allow to useing extended power wire.The socket position should be suitable.

Maintenance instruction

1.Clean the acrylic surface :

Clean acrylic surface with cotton flannel or sponge and water in daily life. If there is scratch on the surface, please use No. 1500 water abrasive cloth polishing slightly to clear away scratches, and then polish with toothpaste, cotton flannel. Please don't use strong caustic chemical liquid, such as sulphuric acid, hydrochloric acid, lye during maintenance.

2.Plated item maintenance:

Clean the surface of plated item with cotton flannel, please don't use coarse cloth.

3.Suction net cleaning:

Turn the screw out and take the suction net out to clear dirt, to keep the water going through smoothly. Don't use strong causticity chemical liquid to clean the product, such as sulphuric, hydrochloric acid, lye and so on.

CONTENTS

- 01-02 Components instructions
- 03-12 Water and electricity installation diagram
 - Faucet pipe connection diagram
 - Installation steps
 - Massage bathtub installation diagram
 - Faucet instructions
 - Computer control panel instructions
 - Maintenance service card
- 13-14 Common trouble shooting

A M196JDTS-1Z Components Instructions

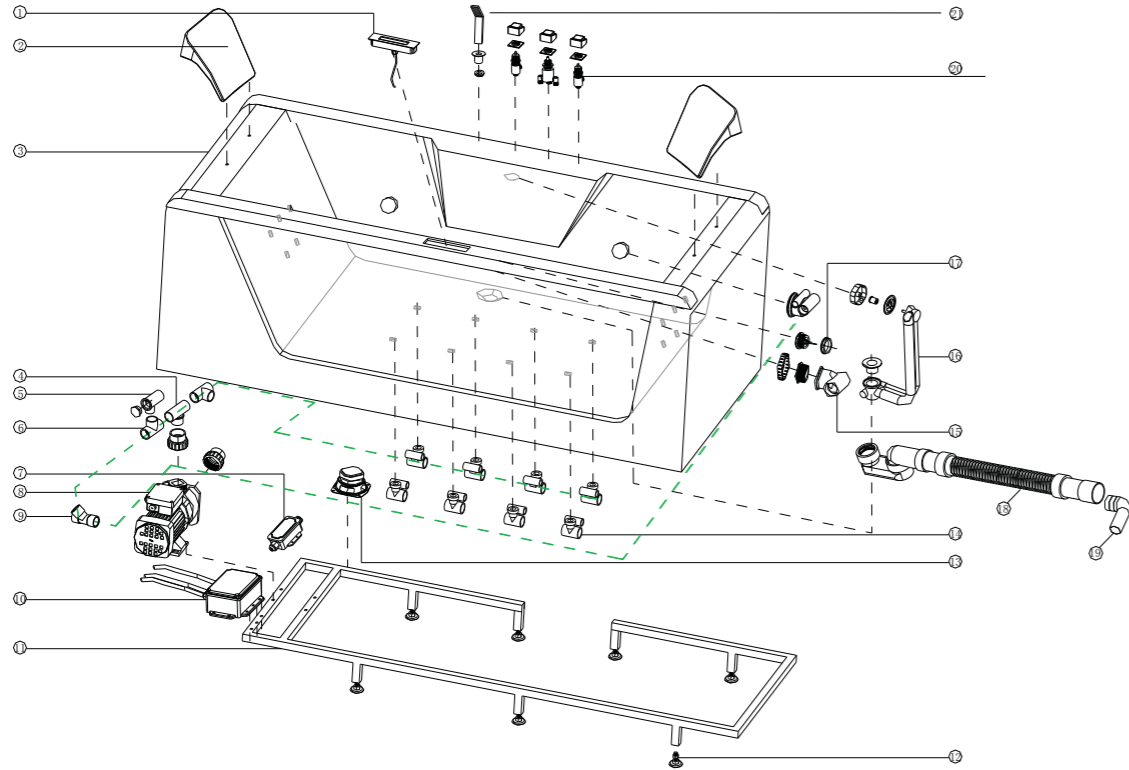

A M196JDTS-1Z Components Instructions

1. Control panel	2. Pillow	3. Bathtub	4. A07 extended plastic	5. exhaust valve	6. Three-way valve
7. Wires connection box	8. Water pump	9. Skew three -way valve	10. Computer panel	11. Stainless steel frame	12. Bathtub leg
13. Loudspeaker	14. Back nozzle	15. Plastic back water	16. Drainer	17. Bottom underwater lamp	18. Isolated stink
19. Plastic flexural drainage pipe connector	20. Faucet	21. Shower head			

AM196JDTS-1Z Water and electricity installation diagram

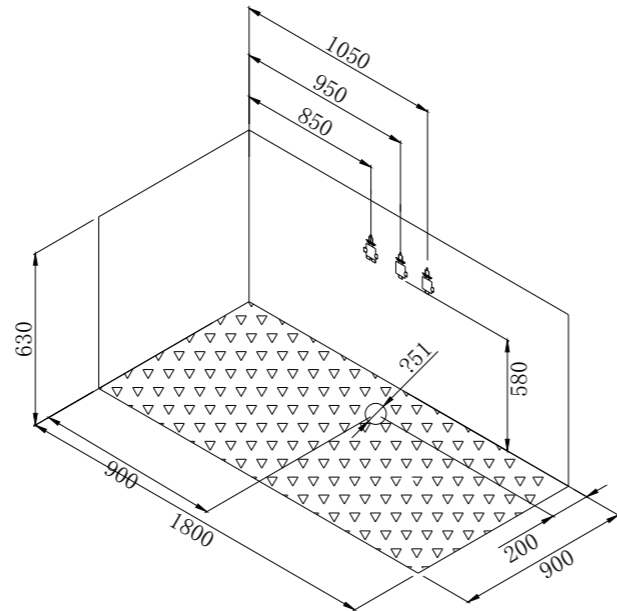
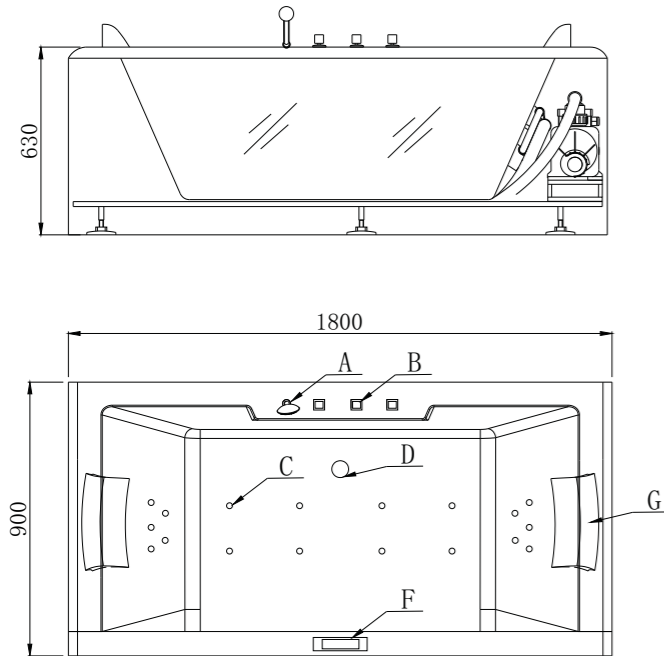

Water pipe of faucet connection diagram

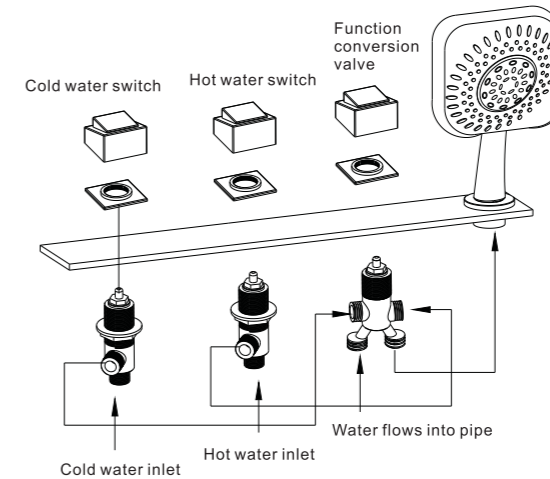

Installation Steps

The product adopts standard accessories, please follow product specifications to install product:

1. Confirm product installation place→2. adjust product to level→3. connect water inlet and drainage pipes→4. connect power→5. check and clean→6. reset→7. test with water.

1. Confirm product installation place

Please refer product specifications to arrange sewage pipes, power socket and water inlet pipe, then check if there is enough space to connect every part.

2. Adjust product to level

Adjust movable ground leg of product till level.

3. Connect water inlet and drainage pipes

Installation Steps

Drainage pipe is in the bottom of tub, the diameter of water drainage outlet is 38mm, and pipe could be bended and stretched; inserting drainage pipe elbow of tub into customer's drainage system pipe with adhesive tape or glass cement during connection. In case of influencing draining water, pipe could not be folded or squashed.

4. The Power Connection

The product is adequate for all purchasing requirement power, please follow technical parameter to install power socket and prevent from water, put plug into power socket. (Note: yellow & green wire of water pump are ground wires, diameter of ground wire is 8mm)

5. Check and clean

After above steps, please check that if the each joint is sealed well, and then clean up sundries of tub. Open drainer to clean tub with water. To prevent sundries or floating objects stuck in water pump from pipes and nozzle jamming; please clean sundries out from tub.

6. Reset

Move product to installation place.

7. Test with water

Please confirm the tub is cleaned up, and then close drainer to store water. Check if there is leakage during water test. Till water is higher than water level probe, follow functions instruction of control panel to operate product.

Wires connection of massage bathtub installation diagram

Electric parameter

Spare part Parameter	Massage pump	Ozone generator	Bottom camp	Magnet valve	Computer control panel	Loudspeaker	Notes
Rate voltage	AC220-240V/50HZ	AC12V	DC12V	DC12V	AC220V/50HZ		
Rate voltage	AC110-120V/60HZ	AC12V	DC12V	DC12V	AC120V/60HZ		
Rate power	1125W	5W	3W	5W		15W	

TS-1 Control system wires connection diagram

TS-1 Luxurious massage bathtub installation wires connection diagram

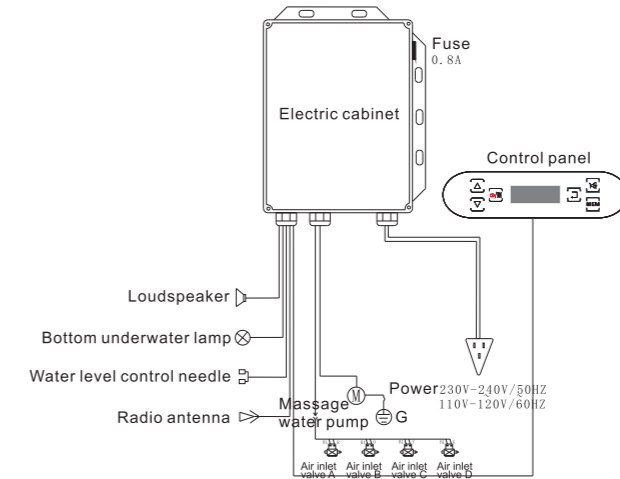

Electric parameter

Spare part Parameter	Massage pump	Ozone generator	Bottom camp	Thermostat	Magnet valve	Computer control panel	Loudspeaker	Notes
Rate voltage	AC220-240V/50HZ		DC12V		DC12V	AC220V/50HZ		
Rate voltage	AC110-120V/60HZ		DC12V		DC12V	AC120V/60HZ		
Rate power	1125W		3W		5W		15W	

Test with water steps

The product uses standard accessories, please refer to product tech parameter and follow the installation steps:

Confirm the installation place of product→connect drainer→connect pipes→check and clean→test with water.

1. Confirm the installation place of product. Please refer tech parameter to arrange sewage pipe, power socket, water inlet pipe, and check if there is enough space for connection.

2. Connect pipes

Drainage pipe is in the bottom of bathtub, the diameter is 38Φ, and the pipe could be bended optionally. Please put angle bend of drainage pipe into customer's drainage pipe of drainage system with adhesive tape or glass cement to seal it.

3. Connect water inlet pipe

Water inlet pipe is chequered tube with high pressure resistance. Please connect cold and hot water joints as direction. For convenient using and maintaining, please install valves in cold and hot water supply pipes.

4. Check and clean

After above steps, please check that if each joint is sealed well, and then clean up sundries of bathtub. Open drainer to clean bathtub.

5. Test with water

Please confirm the bathtub is cleaned up, and then close drainer to store water. Check if there is leakage during water test.

Faucet switch diagram

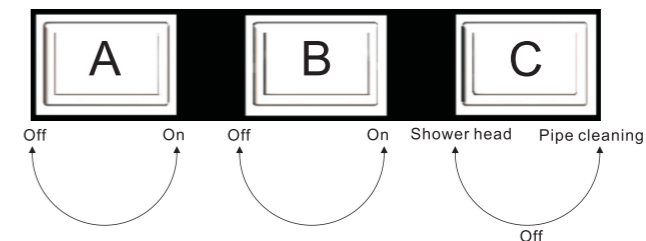

Instruction

1. Faucet of bathtub

3-piece faucet instruction:

- A. Red symbol in water inlet pipe is for hot water, H symbol is under faucet handle. Turn left to start function to adjust water spray capacity of hot water. Max rotation angle is 90°.
- B. Blue symbol in water inlet pipe is for cold water, C symbol is under faucet handle. Turn left to start function to adjust water spray capacity of cold water. Max rotation angle is 90°.
- C. It is function transformation valve, turn left 90° is shower head function, turn right 90° is pipe cleaning function.

TS-1 Computer control panel instruction

TS-1 Computer control panel

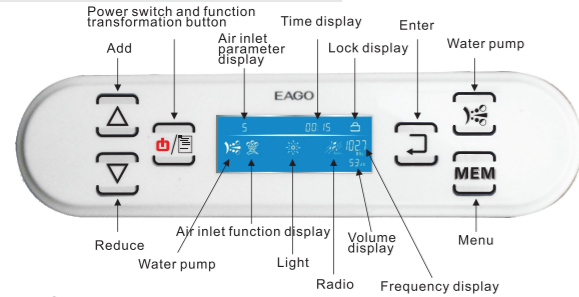



Basic function instruction

1. Touch induction button. When touch induction button operation is effective, each touch will sound "tick". If touch induction button operation is not effective, system will not response.
2. LCD display
3. Radio
4. Water pump, controlled by water level.
5. Bottom underwater lamp
6. Air inlet control, controlled by water pump and water level.
7. Working time display

Buttons operation

1. Power switch and function transformation button

Touch this button 1 second to turn on/off operation. System will turn off automatically after turn on system 60 minutes. Touch the button short time to transform function after turn on system. When display screen flickers icon and  symbol displays below, touch Enter to turn on this function, the icon will not flicker after this function is started. Touch this power switch

button again,  turns to next function icon, the function icon flickers, touch  to turn on this function. Repeat as this circle.

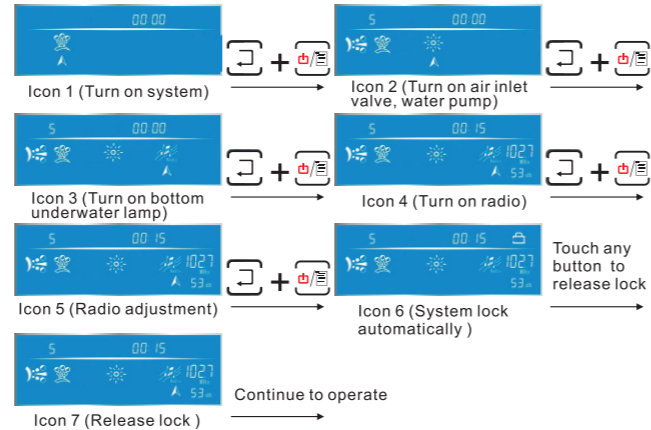

2. Water pump

Touch this button once to turn on water pump, touch this button twice to turn off water pump. Water pump is controlled by water level,  button has nothing response if water level does not reach water level probe.

3. Enter

When the function icon of the button displays on screen formally, and  is on flickered function, touch this button to turn on the function icon.

4. Menu

When radio function is on, touch this button to transform between frequency adjustment and channel saving to operate.

TS-1 Computer control panel instruction



5. Add button

Under frequency beating state, touch this button to add frequency. If touch this button over 1 second, frequency will increase automatically till search 1 channel or reach 108.0 MHZ. Under volume beating state, touch this button to add volume. If touch this button over 1 second, volume will increase till loose the button or reach maximum limit. No icon flickers, touch this button to add volume.



6. Reduce button

Under volume beating state, turn on radio, touch this button to reduce volume. If touch this button over 1 second, volume will decrease till loose the button or reach minimum limit. Under frequency beating state, touch this button to reduce frequency. If touch this button over 1 second, frequency will decrease automatically till search 1 channel or reach 87.5 MHZ. No icon flickers, touch this button to reduce volume.

Light function operation



When  icon is  on, touch enter button for the first time to turn on red light. Touch enter twice to turn on red-green light. Touch enter button third time to turn on green. Touch enter button fourth time to turn on green-blue light. Touch enter button fifth time to turn on blue light. Touch enter button sixth time to turn on blue-red light. Touch enter button seventh, lights circle to lighten, 2s span. Circle order: red, red-green, green, green-blue, blue, blue-red. Touch enter button eighth time to turn off light function.



Air inlet function operation

When  icon is on , touch enter button for the first time to turn on water pump A, turn on 1 air inlet valve at the same time, air inlet parameter displays 1. Touch enter button for the second time to turn on 2 air inlet valves at the same time, air inlet

parameter displays 2. Touch enter button for the third time to turn on 3 air inlet valves at the same time, air inlet parameter displays 3. Touch enter button for the fourth time to turn on 4 air inlet valves at the same time, air inlet parameter displays 4. Touch enter button for the fifth time, air inlet parameter displays 5. Touch enter button for the sixth time, all air inlet valves open 2s, and disconnection 1s at the same time, air inlet parameter displays 6. Circle like this, all air inlet valves are closed for the seventh time, no display on the screen, water pump continue to work. Circle order: 1 valve, 2 valves, 3 valves, 4 valves, 3 valves, 2 valves, 1 valve. Air inlet function is controlled by water level and water pump (only turn on water pump can turn on air inlet valve); when water level does not reach water level probe, no response if touch .

Release lock operation:

No operation on the panel 30s, system will lock automatically, on the top right corner displays  on the panel, touch any button for a short time can not operate panel. Touch (about 1 minute) any button on the panel can release lock, the top right corner  disappear, then operate on the panel.

Time display: lighten the panel, screen displays  and begin to count time. When system works to , system will turn off automatically. If you want system continues to work, touch power switch for a long time to restart.

Automatic water drainage function: Turn off system, open drainer to drainage water. When water level is lower than probe, open water drainage magnetic valve 30 minutes. (Individual products have this function, customer does not operate this function.)

Skirt panel light: Under system is started, skirt panel light lightens all the time. Turn off system, skirt panel light turn off automatically. (Individual products have this function, customer does not operate this function.)

Trouble shooting

Malfunction	Cause	Solution
Too much noise or shake of massage bathtub	<ol style="list-style-type: none"> 1. Bottom stand doesn't balance, nut is unscrewed. 2. Fixed screw or shockproof rubber of motor is loosen or not enough. 3. Motor racing. 4. Motor malfunction. 	<ol style="list-style-type: none"> 1. Put bathtub on the ground, adjust the balance of the bottom stand, then screw down nut. 2. There should be four screws and four shockproof gasket to fix motor, and fix screws tightly. 3. Add water to standard level till water level is higher than probe screw. 4. Contact distributor or EAGO company.
Motor of massage bathtub works normally, but there is no water spray out or water pressure of jet is abnormally.	<ol style="list-style-type: none"> 1. Part of backwater net is stuck. 2. Water level is low. 3. Water regulator is closed. 4. There is air in water inlet pipe of water pump. 5. Others. 	<ol style="list-style-type: none"> 1. Tear down screws of backwater net to clean, and clean up sundries to keep back water net works freely. 2. Add water to standard level to keep it higher than probe screw. 3. Turn on regulator. 4. a) Turn on cleaning function valve to discharge air. b) Screw down water inlet pipe of water pump with each component to prevent air in pipe. c) Turn off cleaning valve. 5. Water pipe and air pipe connect reversely, ask distributor to mend.
Massage motor or air pump motor could not be started.	<ol style="list-style-type: none"> 1. Voltage is abnormal or power is off. 2. Fuse is burnt or tripping operation of creeping switch. 3. No display of circuit board. 4. Water level probe doesn't have signal. 5. Pressure switch is broken. 6. Air switch is broken. 7. The air pipe of air switch and water pump is loosened. 	<ol style="list-style-type: none"> 1. Turn on power. 2. Ask professional electrician to check and mend, replace fuse or turn on creeping switch. 3. Contact distributor or EAGO company. 4. Add water to standard level till water level is higher than probe screw. 5. Ask professional electrician to replace the same model. 6. Contact distributor or EAGO company. 7. Connect air pipe renewably.

Trouble shooting

Malfunction	Cause	Solution
Light doesn't work	<ol style="list-style-type: none"> 1. Plug is not connected. 2. Malfunction of transformer. 	<ol style="list-style-type: none"> 1. Connect plug renewably. 2. Contact distributor or EAGO company.
Water inlet flow is small	<ol style="list-style-type: none"> 1. Water inlet pressure is low. 2. Water inlet pipe is stuck. 	<ol style="list-style-type: none"> 1. Check water inlet pressure. 2. Clean dust gauze.
Water isolating valve can't isolate water.	<ol style="list-style-type: none"> 1. Gasket of valve is broken. 	<ol style="list-style-type: none"> 1. Replace a new one.
There is no air come out from air hole of bubble bath.	<ol style="list-style-type: none"> 1. Air pipe is stuck by sundries. 2. Wind pump is closed. 3. Wind pump could not be started. 	<ol style="list-style-type: none"> 1. Take off the jet, dredge the little air pipe with iron wire. 2. Start wind pump function. 3. Check wind pump as its fail to start procedures.
Drainer could not bounce or drain water.	<ol style="list-style-type: none"> 1. Screw is loosen or being adjusted too lower. 2. Travel cable of drainer is broken. Gasket is not flat. 	<ol style="list-style-type: none"> 1. Take off plug of drainer, screw down screws tightly or adjust screws to suitable places. 2. Replace a new one. 3. Take off gasket, then reinstall it.
It could not drain seep.	Separate massage bathtub could not drain water for its special construction.	