

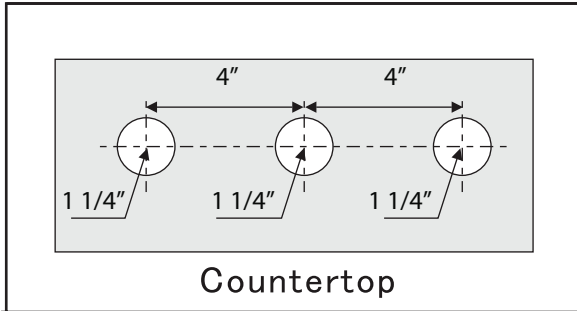

Installation instructions for 80451-xx - Widespread Faucet



1.

Cut mounting holes to install the faucet.

Notes Verify the dimensions against the actual faucet.

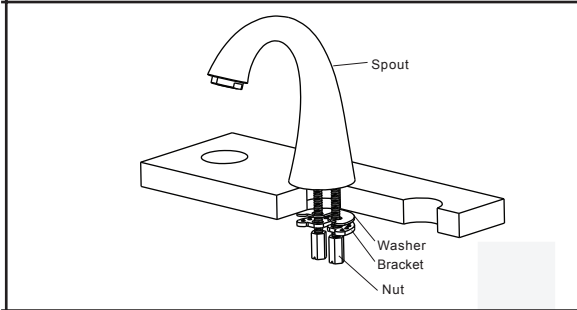

2.

Install spout onto the countertop. Put the mounting bracket onto the threaded rods of the spout and then use the lock nuts to tighten until the spout does not move.

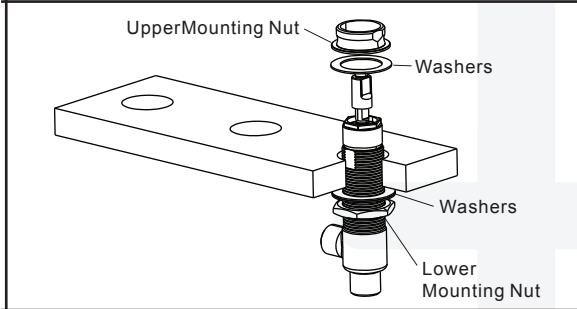

3.

Install valve to the countertop. Remove handle, upper mounting nut and washer.

- 3.1. Install valve from underneath the countertop.
- 3.2. Install the washer and upper mounting nut and turn until it has been tightened onto the valve.
- 3.3. Align the valve into the final position, then tighten the lower mounting nut against the bottom of the countertop.

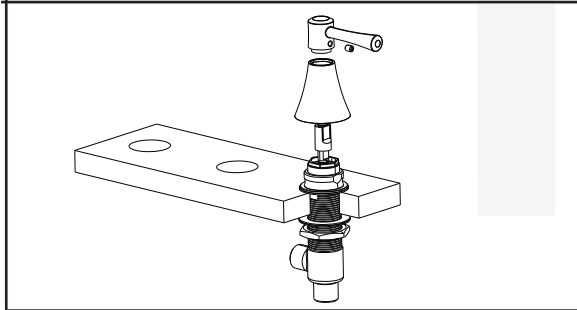

4.

Install escutcheon and handle onto valve, tighten using set screw. If handle does not align to the correct position, you will need to loosen the valve and rotate it to the correct position.

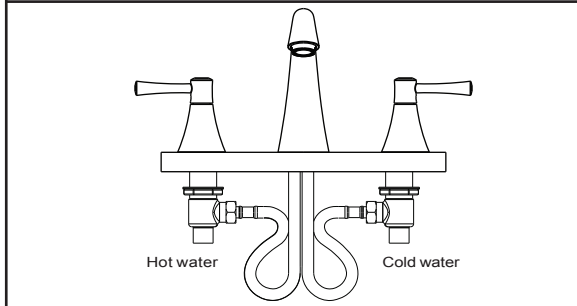

5.

Install hot and cold water supply lines.

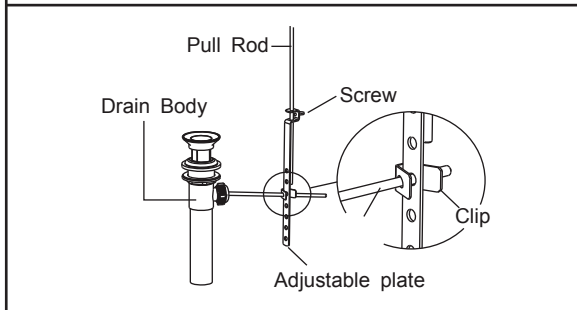

6.

Install the pop-up drain in the bottom outlet of the lavatory as shown. Install washer above and below both the drain body and the lavatory to avoid leakage. Connect the stopper to the drain pipe. After installation, pull the pull rod up and down to check the stopper for proper movement and stopping water.

Notes: The product you bought may come without a pop-up.

After all connections are tightened up, turn on the faucet and flush through water in order to remove impurities and check for any leaks.