



INSTALLATION INSTRUCTIONS

70220-xx - Kitchen Faucet



• 70220-xx

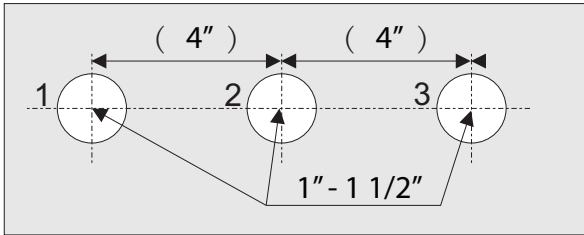

Countertop

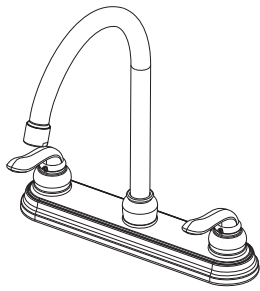

1.

Cut mounting holes to install the faucet. Remove the components (mounting nut and washers) which are attached to the bottom of the faucet. Install the faucet into the pre-drilled hole ensuring the washer is placed between the trim ring and the countertop surface.

Notes Verify the dimensions against the actual faucet. If the faucet you bought has no soap dispenser or side sprayer, do not drill hole for it

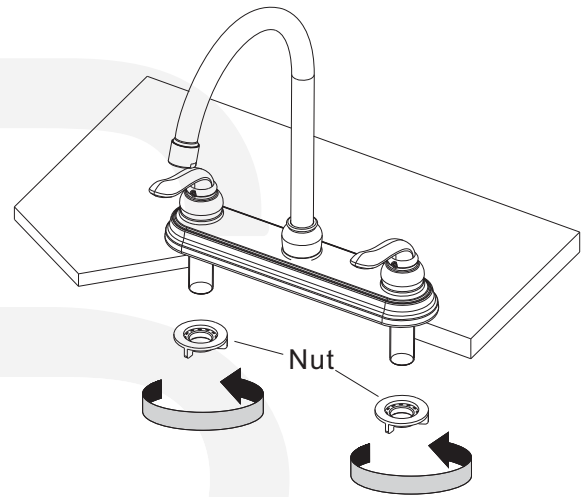

2.

As shown above please install the washers and mounting nut and turn, then secure the faucet to the countertop by tightening the mounting nut clockwise.

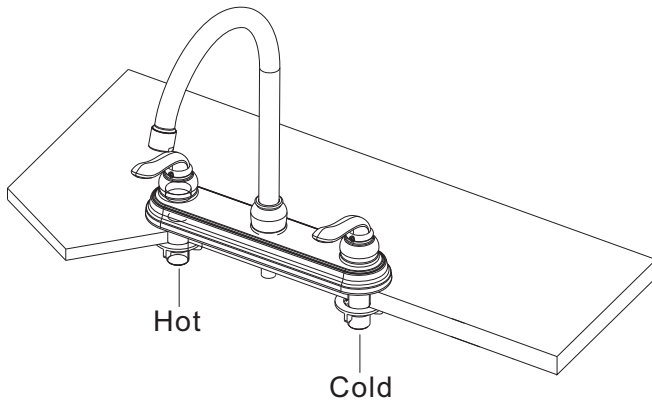

3.

Connect hot and cold hoses following the drawing.

After all connections are tightened up, turn on the faucet and flush through water in order to remove impurities and check for any leaks.