

Tools You Will Need

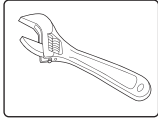

Plumber's putty



Adjustable Wrench

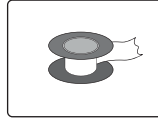

Pipe Tape

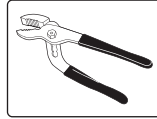

Groove joint plier

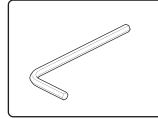

Allen Wrench

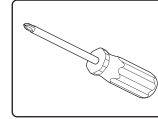

Phillips Screwdriver

Before Your Installation

- Read all instructions carefully.
- Assemble all tools.
- Turn off main water supply before removing old faucet and fixtures.
- Clean surface before installing new faucet.
- Insert a cloth or stopper into drain to prevent small parts from getting lost.
- HB recommends that when cleaning you HB faucet to only use soap and warm water. The use of any chemical substance will void finish warranty.

Tips for Successful Installations

- Use joint compound or Teflon® tape on all threaded connections to prevent leaks.
- Use a soft cloth to protect the faucet's finish when using a wrench, pliers or other tools that could scratch the faucet.
- Tighten all hose connections by hand. Do not over tighten.
- Before turning main water supply back on, open several faucets around the house to prevent pressure from building up. Remove aerator from faucet before turning on water. Flush drain for several minutes before replacing aerator. DO NOT use joint compound or Teflon® tape to reconnect aerator.
- DO NOT use "plumbers putty" or any oil based sealant. HB recommends silicon caulking to be use to seal drain flange and other parts.
- If you experience problems with the installation consult a professional plumber.

14630-xx

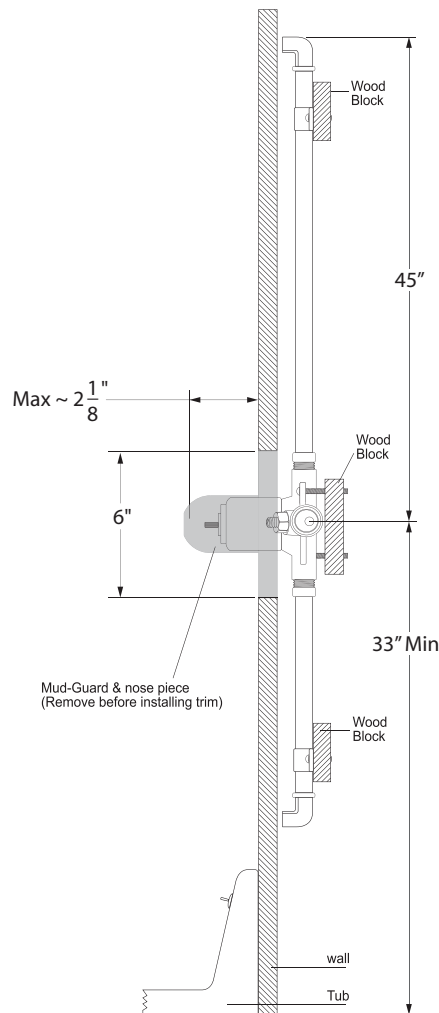

Trim & Handle Installations

Once the location has been determined, install a crossbeam. Level the valve and secure to the crossbeam. Connect valve to the hot and cold supplies using copper supply lines. (Note: Do not apply heat directly to the valves as this may damage rubber and plastic seals and will void the warranty) Connect the outlet port to the spout & to the shower head.

1. Remove mud guard from valve.
2. Turn on all stop valves and make sure to test the valve function before installing trim.
3. Install sleeve over valve and install face plate with the 2 screws supplied.
4. Install handle adapter if needed.
5. Install handle with set screw.

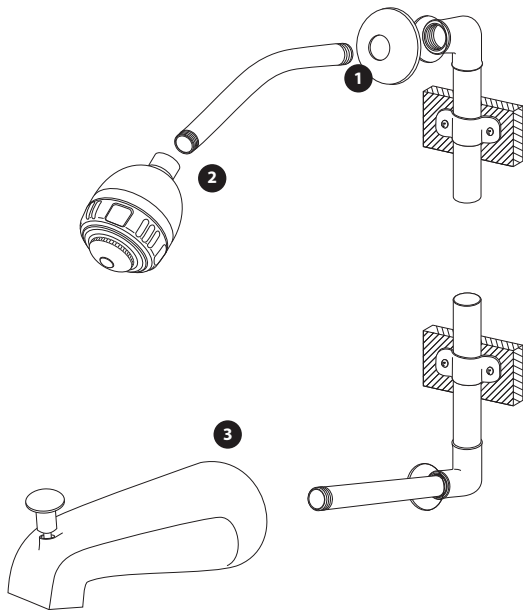

Shower Head / Tub Installations

1. Once the location has been determined, install the shower arm and flange to the fitting.
2. Tighten the showerhead to the shower arm.
3. Tighten tub spout to the fitting.

