

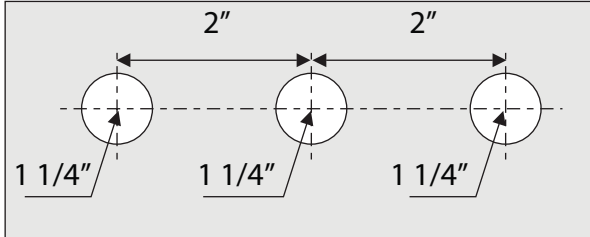

INSTALLATION INSTRUCTIONS

12333-xx - 4" Center Set Faucet



Countertop



• 12333-xx

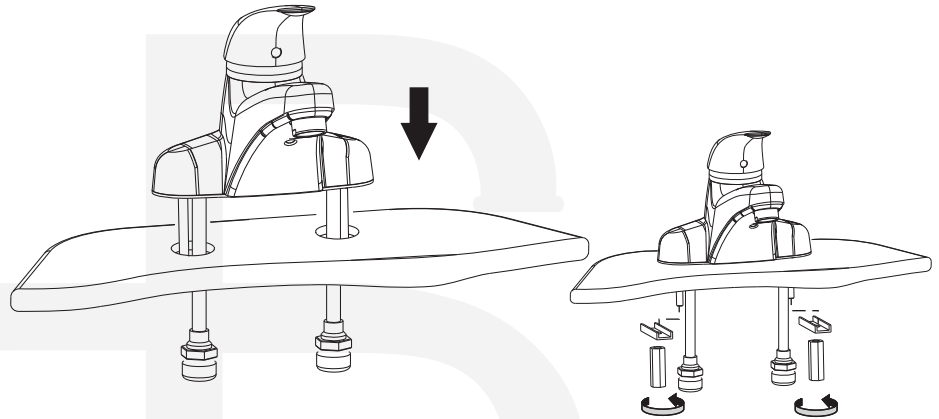
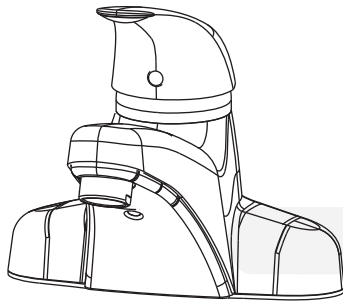

1.

Cut mounting holes to install the faucet. Remove the components (mounting nut and washers) which are attached to the bottom of the faucet. Install the faucet into the pre-drilled hole .

2.

As shown above please install the washers and mounting nut and turn, then secure the faucet to the countertop by tightening the mounting nut clockwise.

Notes Verify the dimensions against the actual faucet.

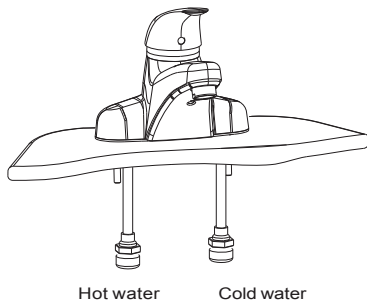

3.

Connect hot and cold hoses following the drawing.

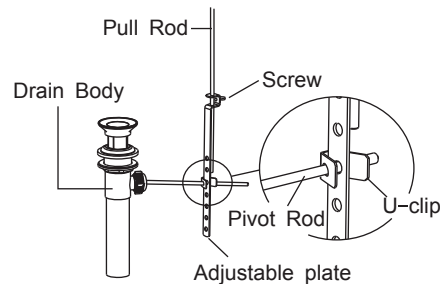

4.

Install the pop-up drain in the bottom outlet of the lavatory as shown. Install washer above and below both the drain body and the lavatory to avoid leakage. Connect the stopper to the drain pipe. After installation, pull the pull rod up and down to check the stopper for proper movement and stopping water. Notes: The product you bought may come without a pop-up.

After all connections are tightened up, turn on the faucet and flush through water in order to remove impurities and check for any leaks.